

M142 Series Application Note

M142 series midranges, currently represented by M142A-6 with aluminum-magnesium dome and M142P-6 with paper dome, having absolutely uncommon design and internal structure in comparison to any midrange driver of this size. The design features convex membrane or dome, voice coil of 137mm diameter, which is almost the same as dome outer diameter and “inverted” magnet system with 109mm ventilation hole. These design considerations were used to achieve lower moving mass for better transient response, higher sensitivity, lower power compression, less internal reflections and better off-axis response. In fact, from its internal structure M142 is very similar to the common dome tweeter. Obviously, dome tweeters or midranges having completely different internal structure in comparison to the classical cone woofers or midranges. Due to these geometrical differences they have different air loading, which will be shown later. Because of certain air loadings in M142, it shows some frequency response irregularity around 1 kHz. There is a 2 db “step” between 950 Hz and 1.1kHz, which can be seen in the graph in the green circle:

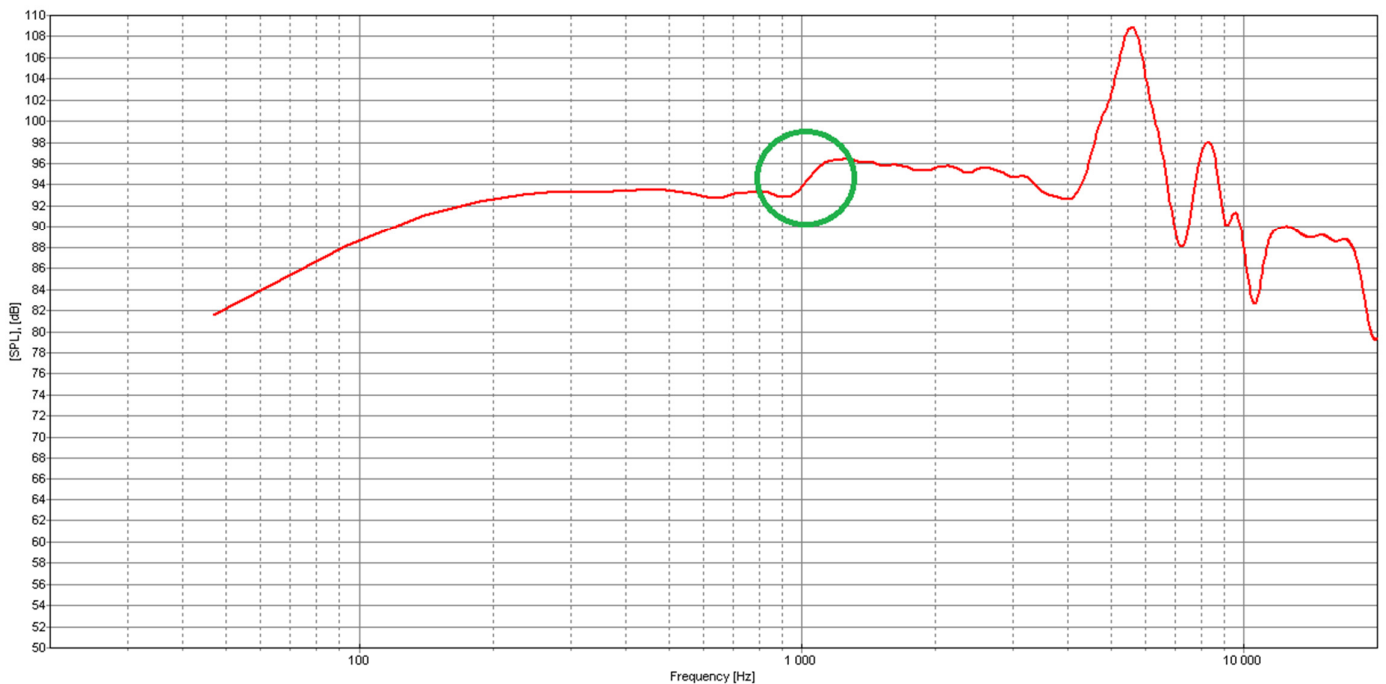

M142A-6 typical frequency response in IEC baffle

This frequency response issue can be easily solved with proper analogue or digital crossover circuit, however a mechanical solution, based on our experience with dome tweeters and dome midranges, can be also used. Here we'll give you a simplified drawings and cross sections of our solution, based on the sample with 30mm front baffle thickness.

Cabinet front baffle cutout

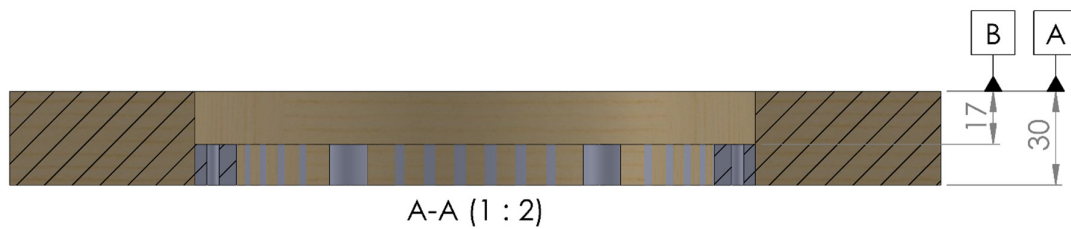
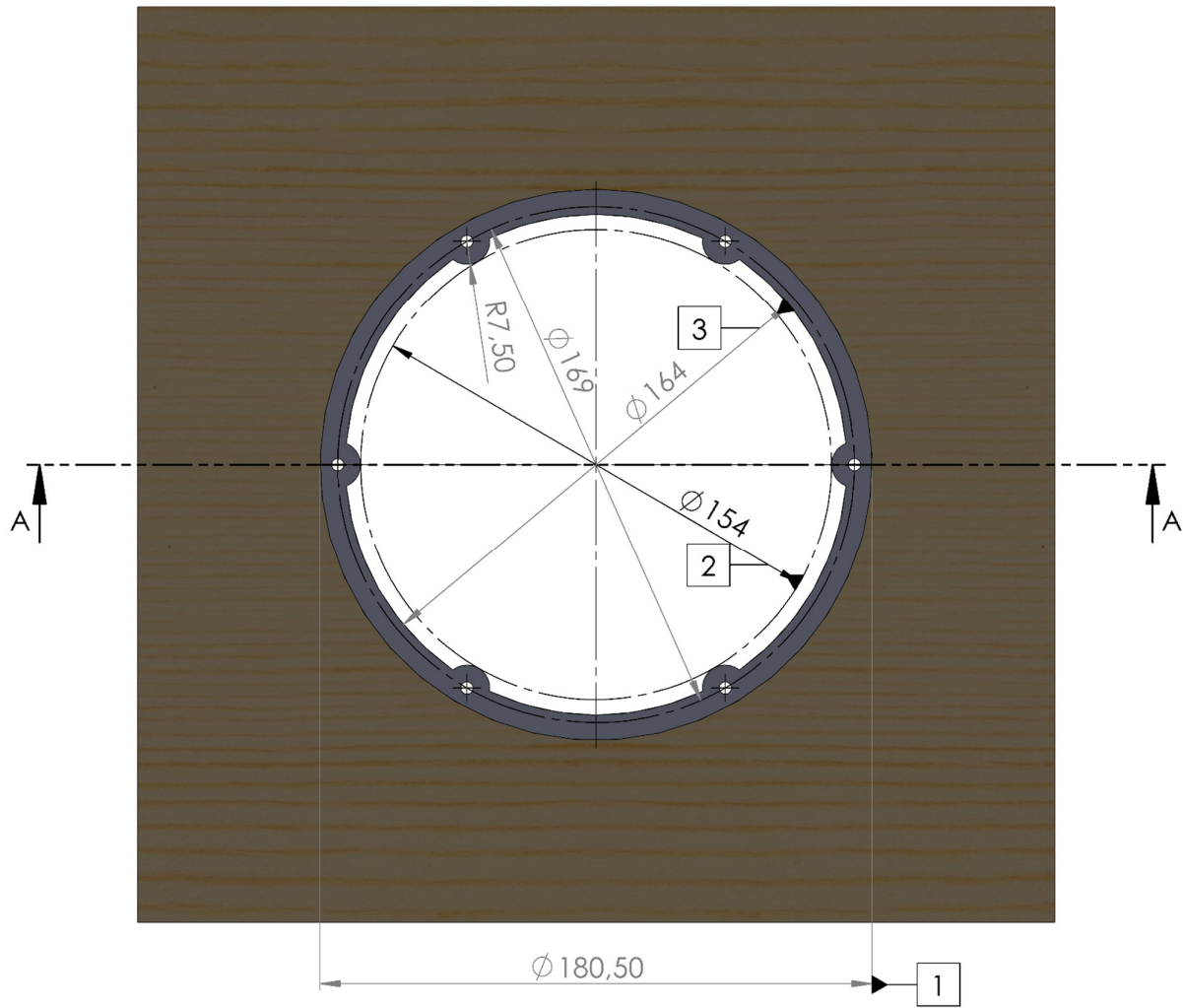

Extension Ring



Back plate as rear wall

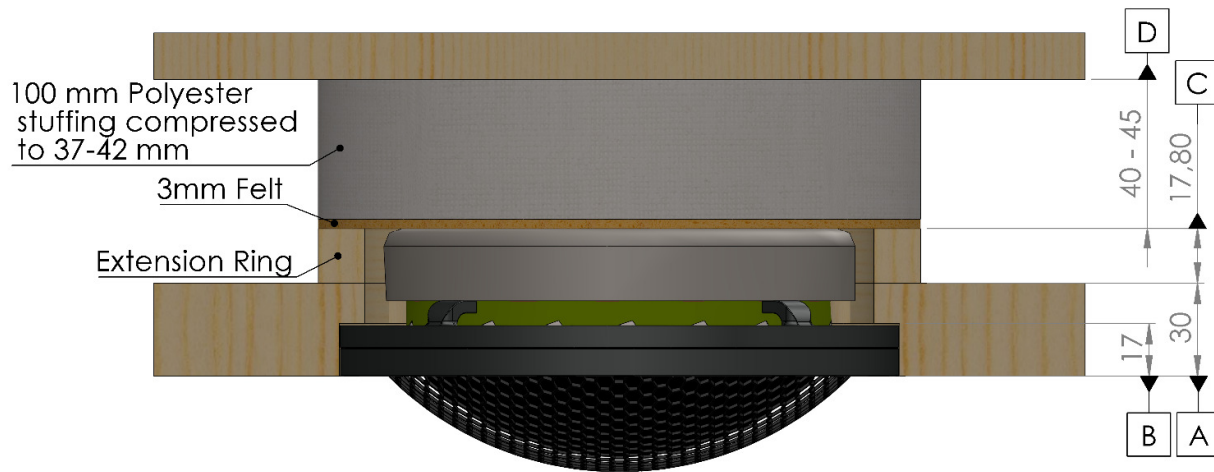

Back plate as rear wall extension

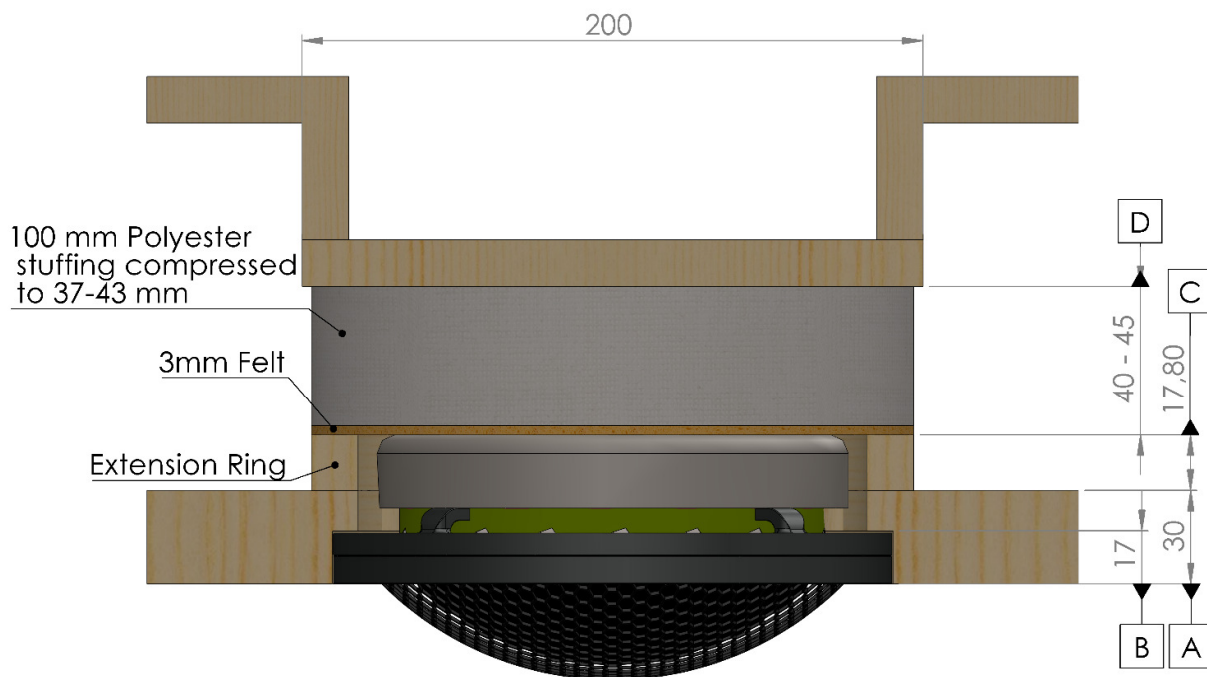

Description of Dimensions

Dimension 1 – 180,5mm is cutout diameter for M142 basket and it has 0,5mm clearance between the basket and baffle cutout and given as an **example** dimension only. Depends on your cabinet material and manufacturing precision this dimension can vary.

Dimension 2 – 154mm is given for enough clearance between M142 magnet system and the smallest opening in the baffle. It should not be less for smooth insert of M142 unit in the cabinet.

Dimension 3 – 164mm is important dimension for the proper air loading.

Dimension A – 30mm given as an **example** baffle thickness. In your particular design it can be any feasible.

Dimension B – M142 basket rim has 16,3mm thickness and obviously, this dimension should be 16,3mm for the flush mounting. However, there is a 2mm gasket on the back side and 17mm given in consideration to the practical gasket compression, which occurs when the mounting screws are tighten. If you do not use original gasket or do not use any gasket at all, this dimension should be changed accordingly to maintain flush mounting.

Dimension C – this is the height of the extension ring. This dimension is directly connected with Dimension A. The sum of dimensions A and C should be 47,8mm. In the listed example with A=30mm, it should be 17,8mm. If your particular baffle thickness is different, this dimension should be recalculated.

Dimension D – this is the distance between the extension ring bottom and M142's magnet system bottom to the back plate or cabinet rear wall. This dimension should be in range between 40mm and 45mm to give you more freedom for your cabinet volume and internal design.

Explanation of Solution

In order to achieve advanced air loading for M142 midrange:

1. The 164mm internal diameter tube connected to the back side of the basket it is required. This tube should be 31,5mm high, which will set its open end flush with M142's magnet system bottom. This is highly important condition! If your particular cabinet front baffle thickness is 48,5mm or more, you can simply use the "Cabinet Front Baffle Cutout" template to maintain proper height of the tube. In case of less thick baffle, you should use "Extension Ring" part, to maintain proper height of the tube, as it shown in our example with 30mm baffle thickness. The outer dimension of this extension ring can be any applicable and will depends on used material, however it should be quite rigid. If you will use plywood or MDF, it should be at least 184mm for 10mm wall thickness. If you'll use aluminum tube or any other metal, the wall thickness can be reduced to 2-3mm, thus outer diameter can be 166-168mm.
2. The natural wool 3mm thick felt* piece should cover both tube and magnet system bottom ends. This felt piece should be pressed by 100mm thick polyester stuffing* as it shown in the both examples in the page 3.
3. Both felt and polyester stuffing should be firmly pressed. This is highly important condition! Due to our researches to press them properly, a rigid plate, which covers whole surface of polyester stuffing is required. Also, the proper pressure can be achieved if the rigid plate placed in 40-45mm from the M142's magnet system bottom. As can be seen from 2 examples from page 3, you can make your cabinet back wall as narrow as 40-45mm to the M142's magnet system bottom or if you like to set your cabinet wall deeper, you can place some rigid plate of 200x200mm or more in 40-45mm from M142's magnet system bottom.
4. The closed box cabinet is required. Most flat frequency response can be achieved in 2,5-3 l net volume enclosure. To calculate net volume, please exclude the volume of the extension ring and additional rigid back plate, in case you are using them.

Using aforementioned design considerations, following frequency response can be achieved:

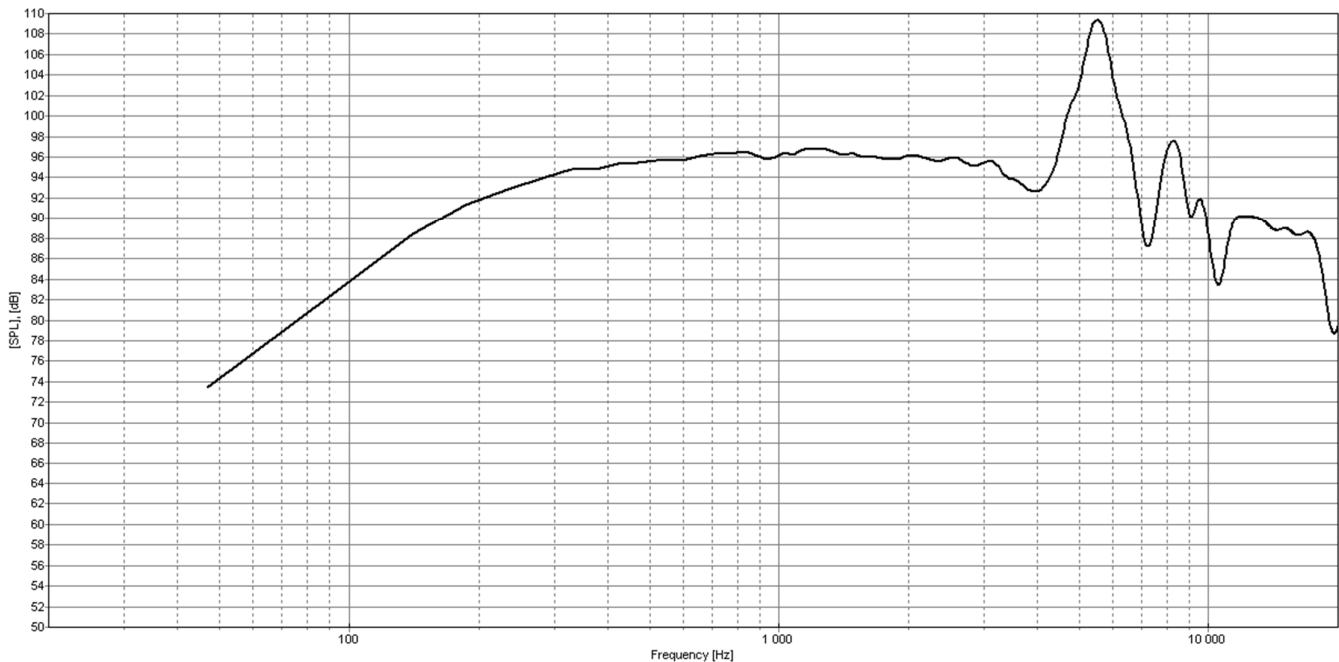

M142A-6 frequency response with air loading solution in 2.9 l closed box in IEC baffle

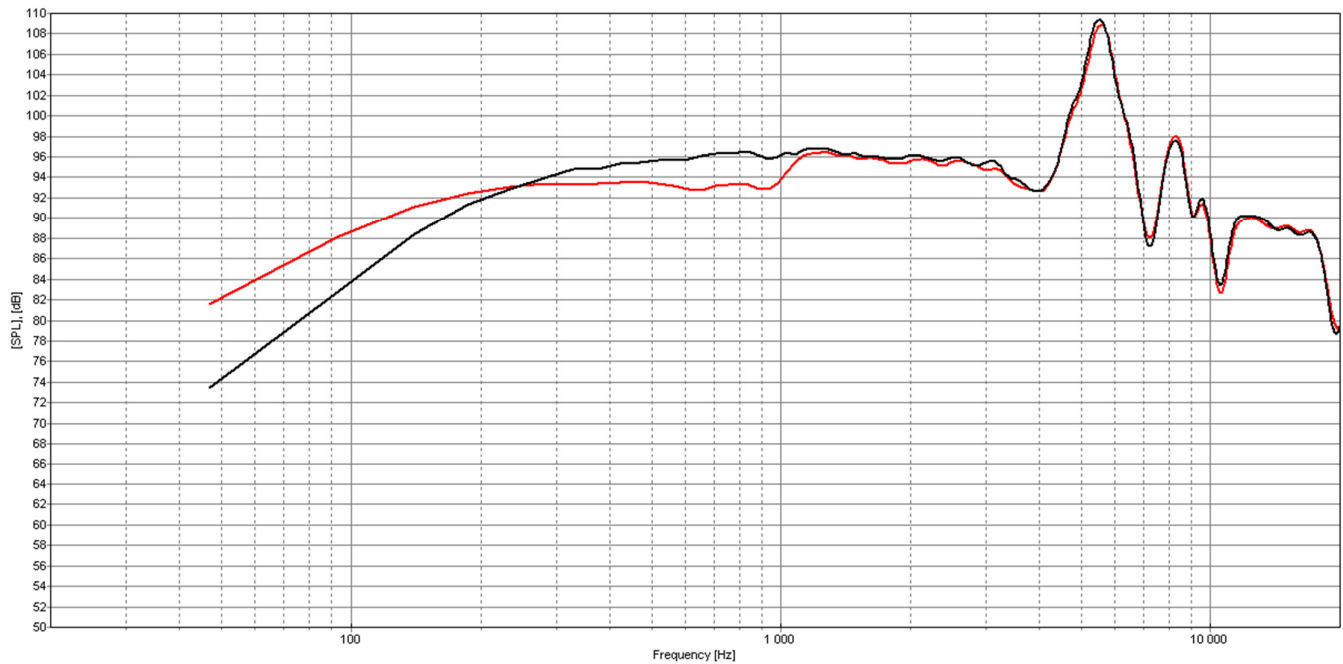

M142A-6 frequency response comparison with and without air loading solution in IEC baffle

Important Notes

1. We used 3mm natural wool felt 0,25g/cm³ dense and 5 layers of 20mm thick polyester stuffing blanket 200g/m² dense. If you'll use different materials, the result frequency response can vary. BliesMa® will gladly support you with purchasing suitable felt and polyester stuffing on demand.
2. All frequency responses listed in the current Application Note were measured in IEC baffle. In your particular loudspeaker cabinet baffle they can vary.
3. M142A-6 air loading solution was explained. This solution is feasible for all M142 range.